

Vental Model 80a + 50a - External Venetian Blind

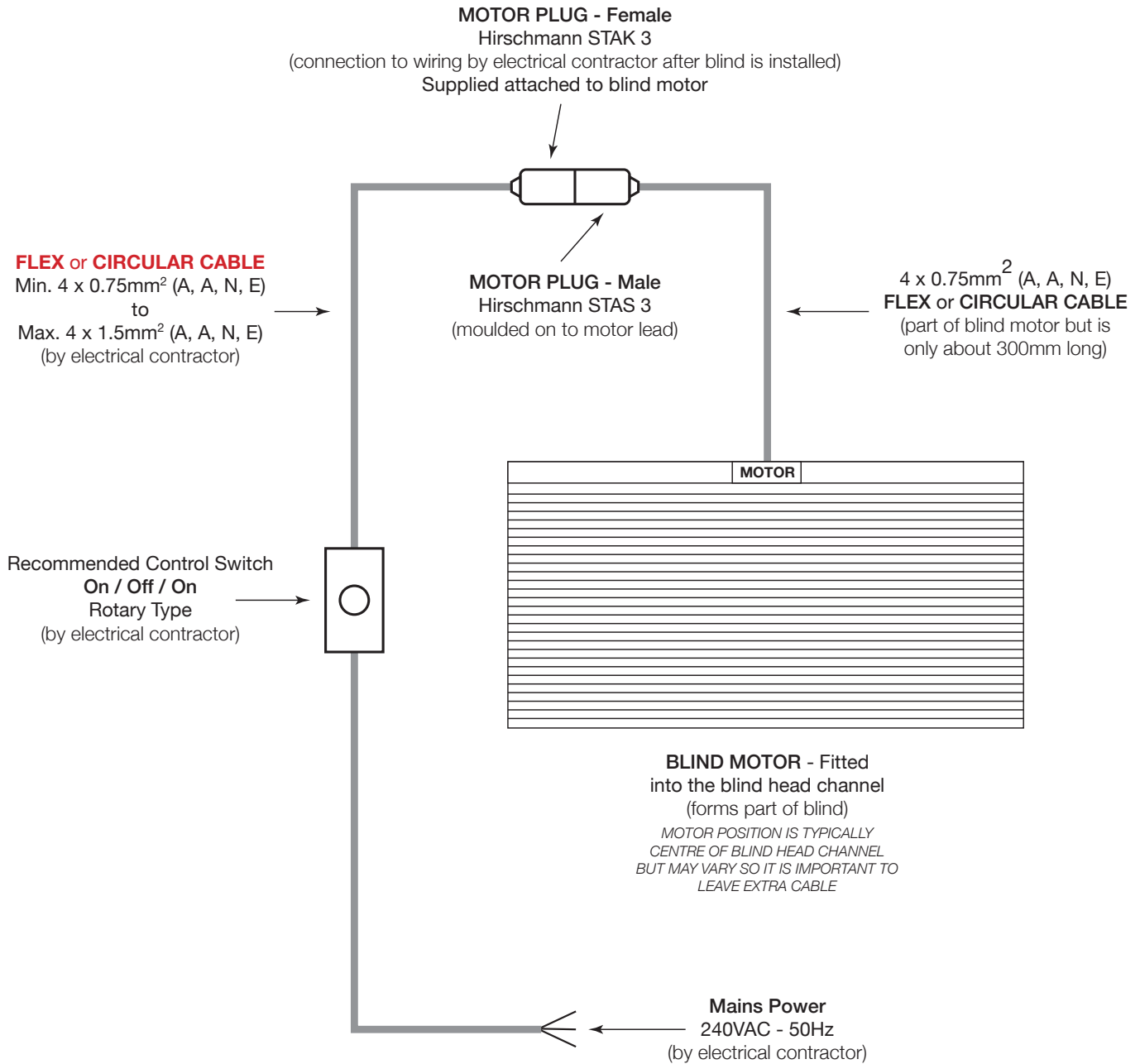

Standard Wiring Flow for Single Motor to Single Wall Switch

Ref: VA9001d



IMPORTANT NOTE:

Do not ever connect venetian blind motors in parallel under any circumstances.

Parallel connection will damage the motor and will cause an early life failure so is excluded from blind motor warranty.

Vental Model 80a + 50a - External Venetian Blind



Standard Wiring Connection for Single Motor to Single Wall Switch

Ref: VA9002a

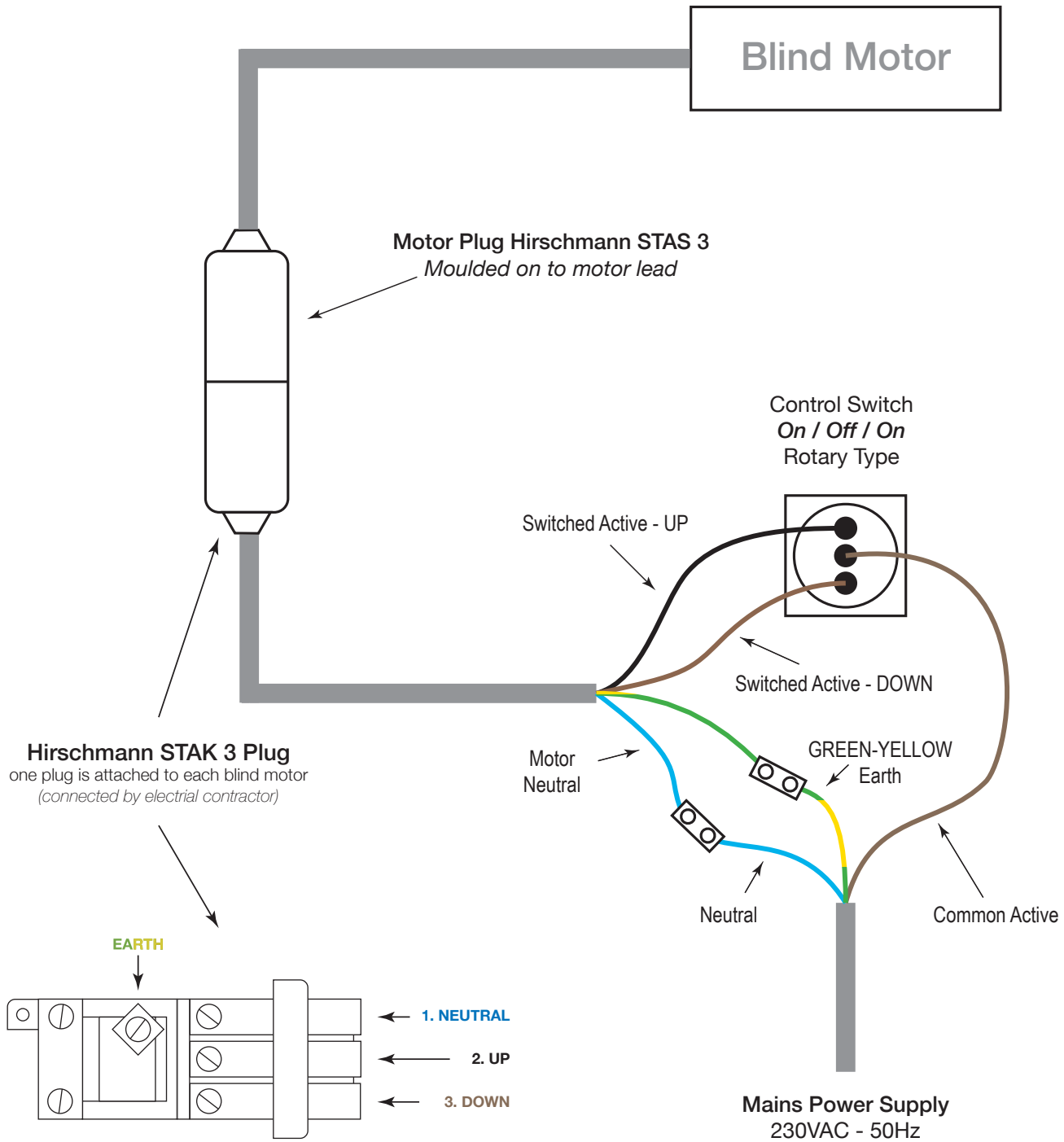

IMPORTANT NOTE:

Do not ever connect venetian blind motors in parallel under any circumstances.

Parallel connection will damage the motor and will cause an early life failure so is excluded from blind motor warranty.

Data Sheet

Excel Life™

Rotary Switch Mechanism -
Options 180°, 270°, 360° - 16A

CAT NO. **EMRS**



Cat No	EMRS
Description	Excel Life Rotary Switch Mechanism - Options 180°, 270°, 360° - 16A
Supply voltage	230 - 240V a.c.
Current rating	16A, 10AX (fluoro)
Colour	White (WE), Urban Grey (UG)
Compliance	AS/NZS 3133

Excel Life™ Rotary Switch Mechanism - Options 180°, 270°, 360° - 16A

CAT NO. **EMRS**



Wiring for 360° rotation

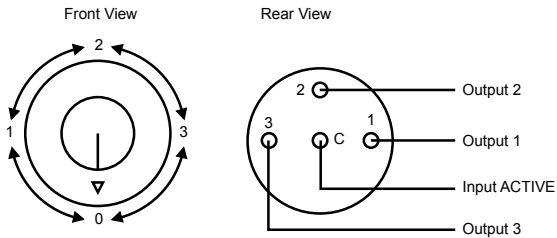

Select one of the following wiring options:

POSITION				WIRING
0	1	2	3	
OFF	ON	ON	ON	Connect All Terminals
OFF	ON	OFF	ON	Do Not Connect Terminal 2

Wiring for 270° rotation

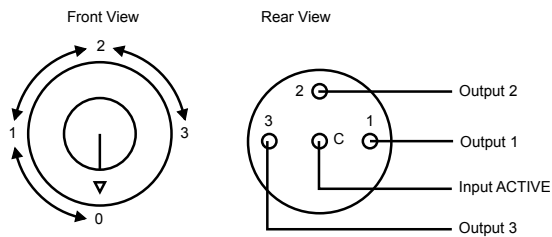

Select one of the following wiring options:

POSITION				WIRING
0	1	2	3	
OFF	ON	ON	ON	Connect All Terminals

Wiring for 180° rotation

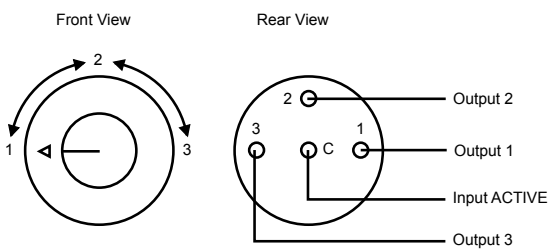

Select one of the following wiring options:

POSITION			WIRING
1	2	3	
ON	ON	ON	Connect All Terminals
ON	OFF	ON	Do Not Connect Terminal 2
OFF	ON	ON	Do Not Connect Terminal 1
ON	ON	OFF	Do Not Connect Terminal 3

Excel Life™ Rotary Switch Mechanism - Options 180°, 270°, 360° - 16A

CAT NO. **EMRS**



- Combines the 180°, 270° and 360° products into 1
- Easy grip, lower profile knob

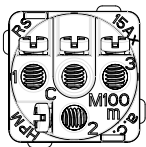

RS

Marking plate options

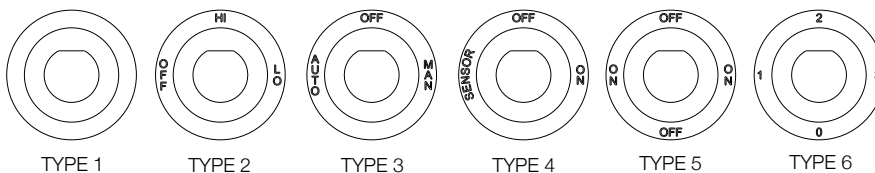

Product specifications	
Cat No	EMRS
Supply voltage	230-240V a.c.
Current rating	16A, 10AX (fluoro)

Single product	
Cat No	Barcode
EMRSWE	9321001401933
EMRSUG	9321001411741

Inner box (QTY 10)		
Cat No	Barcode	Dimensions
EMRSWE	9321001404378	124 x 160 x 80mm
EMRSUG	9321001412403	124 x 160 x 80mm

Outer box (QTY 120)		
Cat No	Barcode	Dimensions
EMRSWE	9321001406815	260 x 340 x 260mm
EMRSUG	9321001413066	260 x 340 x 260mm

HPM Legrand - AUS
1300 369 777
www.legrand.com.au
ABN 31 000 102 661

HPM Legrand - NZ
0800 476 009
www.legrand.co.nz

Refer to your group buying office, HPM Legrand Sales Representative or HPM Legrand Sales Office for pricing.

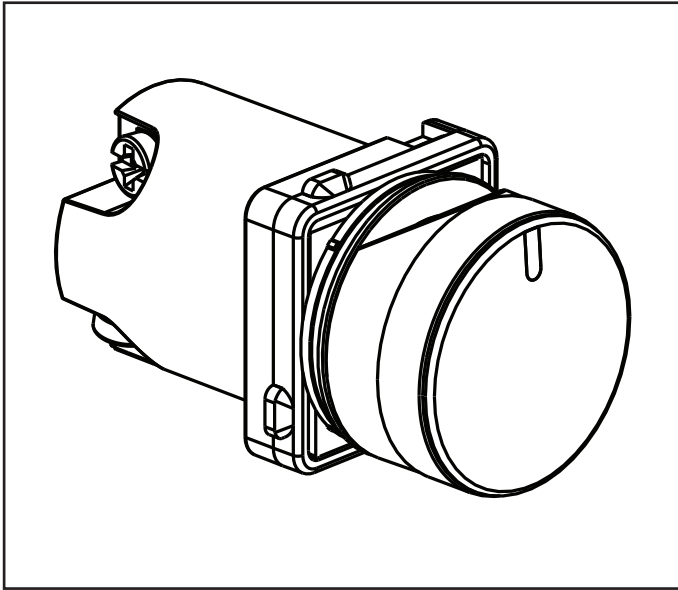

Features

- 3 options for rotation: 180°, 270° & 360°
- 6 marking plate options (refer below)
- Voltage: 230-240V a.c.
- Current rating: 16AX

Installation

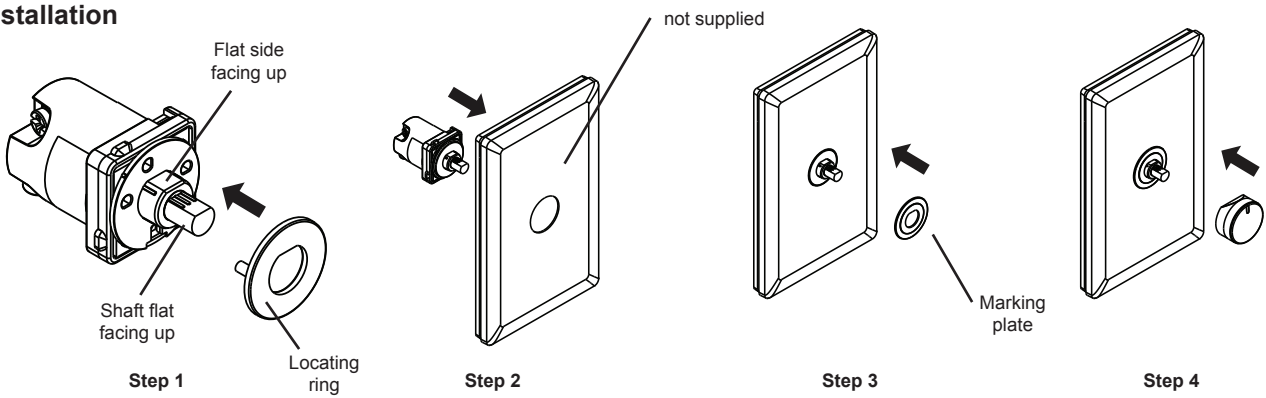

Rotation options (locating ring)

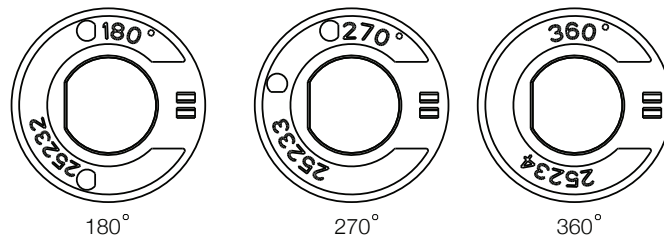

Marking Plate Options

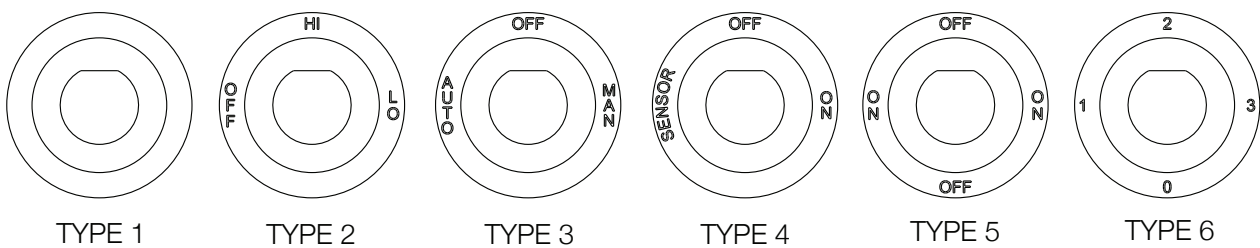

Wiring for 360° rotation

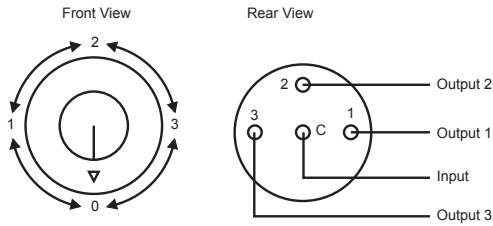

Select one of the following wiring options:

POSITION				WIRING
0	1	2	3	
OFF	ON	ON	ON	Connect All Terminals
OFF	ON	OFF	ON	Do Not Connect Terminal 2

Wiring for 270° rotation

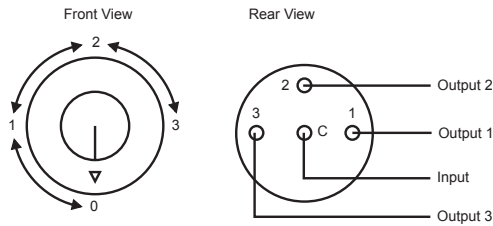

Select one of the following wiring options:

POSITION				WIRING
0	1	2	3	
OFF	ON	ON	ON	Connect All Terminals

Wiring for 180° rotation

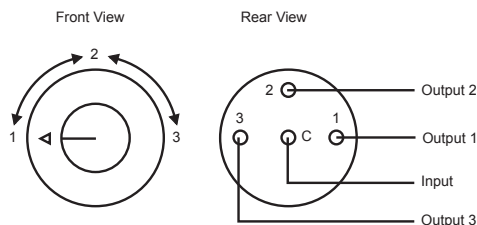

Select one of the following wiring options:

POSITION			WIRING
1	2	3	
ON	ON	ON	Connect All Terminals
ON	OFF	ON	Do Not Connect Terminal 2
OFF	ON	ON	Do Not Connect Terminal 1
ON	ON	OFF	Do Not Connect Terminal 3

Warranty

HPM Legrand will honour all statutory guarantees that you as a consumer are entitled to rely upon under the Australian Consumer Law against a manufacturer including a guarantee that (any products HPM Legrand has manufactured or imported/the products which are described in this Instruction Manual) EMRS products are of acceptable quality.

To make a claim under any statutory guarantee (or other warranty) you should first contact the supplier, contractor or retailer from whom you purchased the products.

Customer Service

For all Customer Service and Technical Support please call Monday to Friday during business hours.

HPM Legrand Australia
1300 369 777
www.hpmlgrand.com.au

HPM Legrand New Zealand
0800 476 009
www.hpmlgrand.co.nz

ABN: 31 000 102 661

Rotary Switches



CAT NO. **770RS180MWE, 770RS270MWE, 770RS360MWE**



Three new rotary switches replace all the old HPM 770RS rotary switches

- 770RS180MWE – 180° rotation with 3 positions
- 770RS270MWE – 270° rotation with 4 positions
- 770RS360MWE – 360° continuous rotation with 4 positions
- Applications include Auto-off-Manual selection (typically sensors), bi-direction switching for blinds and screens, and multi speed control
- Rated 15AX, X rating for fluorescent loads as well
- Motor rating is M100 (improved from M50)
- Colour knobs available: White, Beige, Black, Brown, Cream and Misty Grey (CAT 770RSK)
- Compatible with HPM plates – Standard, Excel, Linea and Architectural Metal



Product specifications	
Cat No	770RS180MWE, 770RS270MWE, 770RS360MWE
Supply voltage	230-240V a.c.
Max load	15AX
Motor Rating	M100

Packaging specifications			
Cat No	770RS180MWE	770RS270MWE	770RS360MWE
Single bag quantity	1	1	1
Single bag quantity dimensions	150Hx100Wx25Dmm	150Hx100Wx25Dmm	150Hx100Wx25Dmm
Single bag weight	22g	22g	22g
Single box barcode	9321001375562	9321001375531	9321001375500
Inner box quantity	10	10	10
Inner box dimensions	70Hx130Wx175Dmm	70Hx130Wx175Dmm	70Hx130Wx175Dmm
Inner box weight	0.36kg	0.36kg	0.36kg
Inner box barcode	9321001375579	9321001375548	9321001375517
Outer (shipper) carton quantity	200	200	200
Outer (shipper) dimensions	370Hx370Wx295Dmm	370Hx370Wx295Dmm	370Hx370Wx295Dmm
Outer (shipper) carton weight	7.2kg	7.2kg	7.2kg
Outer (shipper) barcode	9321001375586	9321001375555	9321001375524

Rotary Switches

CAT NO. **770RS180MWE, 770RS270MWE, 770RS360MWE**

HPM Legrand - AUS
1300 369 777
www.hpm.com.au
ABN 31 000 102 661

Refer to your group buying office, HPM Legrand Sales Representative or
HPM Legrand Sales Office for pricing.

HPM Legrand - NZ
0800 476 009
www.hpm.co.nz